



About the BLHJ

The BLHJ is a superior-grade, suspended mount LED high bay fixture. It is ideal for indoor use, where energy-efficiency, performance and ease of maintenance is essential. Its rugged design makes it an ideal fixture for high bay applications.

Specifications

Supported Voltage	120-277V, 347V, 120-347V
Available Sizes	2', 4'
Lifetime	L70 of 170,000+ hours, L90 of 50,000+ hours
Lumens	2L (2000lm) to 96L (96000lm)
CCT	2700K, 3000K, 3500K, 4000K, 5000K, 6500K
CRI	80+ standard, 90+ and 95+ available
Dimming	1-10V
Mounting	Holes provided for V-hangers, S-hook chain-mounting, or aircraft cables, with optional pendant and surface mount brackets

Approvals

- DLC Listed
- DLC Premium* (select models only)
- ETL certified to UL Canada and United States standards
- Dry and Damp Environment Rated
- 40°C Cold Temperature Ready

Ordering Information

Fill in the fields below with your product selections. If you need help with this section, [contact your local sales professional.](#)

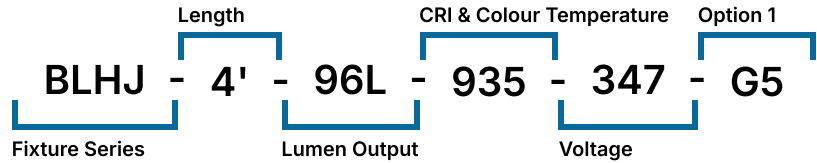

1	2	3	4	5
BLHJ				

Series	Length & Lumen Output		CRI		CCT		Voltage			
BLHJ	2'-10L	10,355lm	4'-20L	20,381lm	8	80	27	2700K	UNV	120-277V
	2'-12L	12,243lm	4'-24L	24,182lm	9	90+	30	3000K	347	347V
	2'-14L	14,127lm	4'-28L	28,255lm	1	95+	35	3500K	UN3	120-347V
	2'-16L	16,140lm	4'-32L	32,239lm			40	4000K		
	2'-18L	18,132lm	4'-36L	36,159lm			50	5000K		
	2'-20L	20,174lm	4'-40L	40,333lm			65	6500K		
	2'-22L	22,230lm	4'-44L	44,190lm						
	2'-24L	24,137lm	4'-48L	48,289lm						
	2'-28L	28,238lm	4'-56L	56,492lm						
	2'-30L	30,087lm	4'-60L	60,170lm						
	2'-32L	32,219lm	4'-64L	64,176lm						
	2'-36L	34,063lm	4'-72L	72,312lm						
	2'-40L	40,052lm	4'-80L	80,104lm						
	2'-44L	44,190lm	4'-88L	88,381lm						
	2'-48L	48,289lm	4'-96L	96,950lm						

Options

Lenses

L0	No Lens
L69	Glare Control Lens
L81	30x60 Aisle Lens*
L82	10x60 Aisle Lens*

* See photometry for lens information

Cords

W3xx	White 16/3 (Specify Length)
W4xx	Black 16/3 (Specify Length)
W59xx	White 18/5 (Specify Length)
W***	Other Options Available*

Key.	Cord Length.	Key	Cord Length
6	6FT	15	15FT
10	10FT	20	20FT

Ex. W406 would be 16/3 Black, 6FT

Dimming

B11	0-10V Dimming Leads
B12	Line Voltage Dimming
B27	Dim-to-off Driver

Wire Guard

G1	Heavy Duty White
G5	Heavy Duty Black

Controls

WC10*	Encelium Wireless Controls
WC18*	NX Wireless Controls
WC19*	Avi-on Wireless Controls
WC22*	JDRF Wireless Controls

Motion Sensors

W26	Photocell Motion Sensor
W57	Dimming Motion Sensor (dims to 50% when unoccupied)
W53*	On/Off
W8*	High/Low
WX16	Microwave Dimmable Sensor
W**	Other Options Available*

Temperature Rating

BLANK	Standard
T0	-40C Cold Rated Components

Electrical

B24	UL924 20W Battery Back-up
F7	20kV Surge Suppressor
F8	UL924 Emergency Relay

Packaging

BLANK	Individually Boxed on Pallets
P0	Bulk Packaging
P**	Other Options Available*

Mounting

M1	V-Hangers
M2xx	V-Hanger with Aircraft Loop Cables
M3xx	Y-Toggle Aircraft Cables
M24	Single Pendant Mount(3/4 Hub)
M25	Surface Mount
M**	Other Options Available*

Key.	Aircraft Length.	Key	Aircraft Length
5	5FT	15	15FT
10	10FT	20	20FT

Ex. M305 would be Y-Toggle, 5FT

Warranty

CL7	10-Year Comprehensive Warranty Upgrade
-----	--

Documentation and Resources

All files and resources are available on our website for download. Files and resources are also embedded as links in this document, listed below. Additional files may be available upon request.
Please contact your local sales agent [here](#) or contact sales@bjtake.com for more information.







 [BLHJ Specification Sheet, 2024](#)

 [BLHJ - Installation Instructions](#)

 [BLHJ - Photometry.zip](#)

Certifications and Listings

Certifications that apply to this fixture and its possible configurations are listed here. More information available upon request.

Icon	Description
	DLC Listed
	DLC Premium* (select models only)
	ETL certified to UL Canada and United States standards
	Wireless Controls Available
	90 and 95+ CRI Options Available
	120-347V(UN3) Available

Usage Applications

This fixture can be used in a variety of applications, and is ideal for the following:

Usage Application
Hospitals
Offices
Schools
Logistics And Warehousing
Manufacturing Plants
Retail Stores
Cold Storage And Freezers
Gymnasiums And Arenas
Professional Sports Facilities

Warranty Statement

BJ Take products are tested and/or inspected prior to being packaged for shipment and are guaranteed from the day the product is shipped for a period of ten-year LED chip warranty and a five-year comprehensive component warranty. This can be upgraded to a ten-year comprehensive warranty on request.

Wattage Information

Below are the wattage tables for all size formats of the BLHJ.

BLHJ 2' Wattage

Size	Lumens	Lens	Lm/W	Lumen Output	Wattage	Ambient Rating
2'	10L	L69	162.67	10427	64.10	-40C to 40°C
2'	12L	L69	160.66	12540	78.05	-40C to 40°C
2'	14L	L69	158.66	14597	92.00	-40C to 40°C
2'	16L	L69	156.65	16597	105.95	-40C to 40°C
2'	18L	L69	154.65	18543	119.90	-40C to 40°C
2'	20L	L69	152.64	20431	133.85	-40C to 40°C
2'	22L	L69	150.63	22263	147.80	-40C to 40°C
2'	24L	L69	148.61	24038	161.75	-40C to 40°C
2'	28L	L69	159.88	28890	180.70	-40C to 40°C
2'	30L	L69	157.97	30750	194.66	-40C to 40°C
2'	32L	L69	156.06	32557	208.62	-40C to 40°C
2'	36L	L69	154.15	36463	236.54	-40C to 40°C
2'	40L	L69	152.24	40261	264.46	-40C to 40°C
2'	44L	L69	150.33	43953	292.38	-40C to 40°C
2'	48L	L69	148.40	47552	320.40	-40C to 40°C

BLHJ 4' Wattage

Size	Lumen Package	Lens	Lm/W	Lumen Output	Wattage	Ambient Rating
4'	20L	L69	159.24	20415	128.20	-40C to 40°C
4'	24L	L69	157.40	24539	155.90	-40C to 40°C
4'	28L	L69	155.57	28563	183.60	-40C to 40°C
4'	32L	L69	153.73	32483	211.30	-40C to 40°C
4'	36L	L69	151.90	36304	239.00	-40C to 40°C
4'	40L	L69	150.06	40021	266.70	-40C to 40°C
4'	44L	L69	148.23	43639	294.40	-40C to 40°C
4'	48L	L69	146.36	47143	322.10	-40C to 40°C
4'	56L	L69	157.09	57149	363.80	-40C to 40°C
4'	60L	L69	155.29	60866	391.95	-40C to 40°C
4'	64L	L69	153.49	64481	420.10	-40C to 40°C
4'	72L	L69	151.68	72260	476.40	-40C to 40°C
4'	80L	L69	149.88	79841	532.70	-40C to 40°C
4'	88L	L69	148.08	87219	589.00	-40C to 40°C
4'	96L	L69	146.25	94375	645.30	-40C to 40°C

BLHJ Light Loss Factor (LLF)

CCT	Scaling Factor
3500	97.19
4000	100.00
5000	100.00
90CRI	85.90

BLHJ Lens Scaling

Order Code	Lens	Scaling Factor
L69	Glare Control Lens	100.00
L81	30x60 Aisle Optic	100.43
L82	10x60 Aisle Optic	101.74
L0	No Lens	110.25

* Actual lumen output may vary

BLHJ 2' 10L-24L Dimensions

Below are the dimensions for the 2' 10L-24L BLHJ configurations.

2' 10L-24L Standard

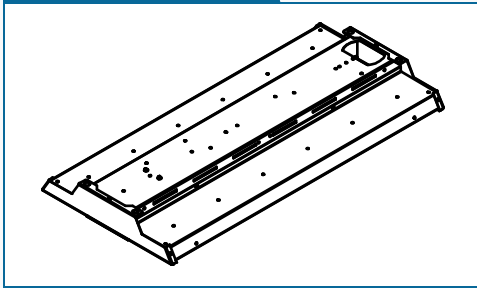

2' 10L-24L Standard End

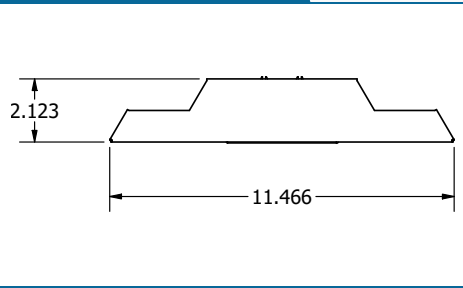

2' 10L-24L Standard Side

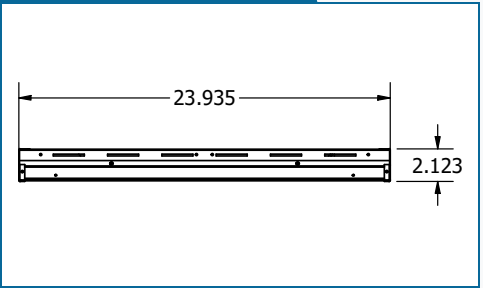

2' 10L-24L Pendant

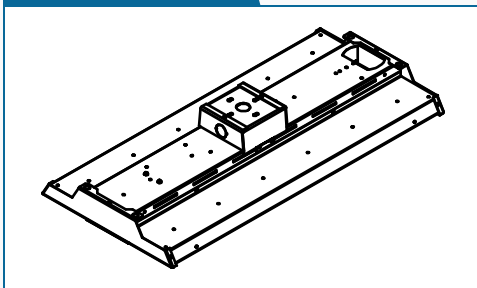

2' 10L-24L Pendant End

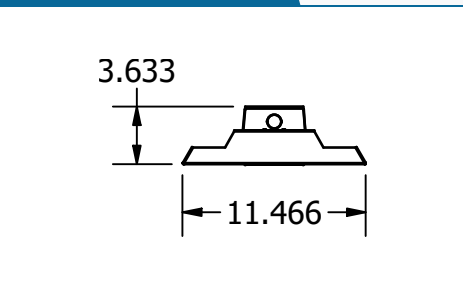

2' 10L-24L Pendant Side

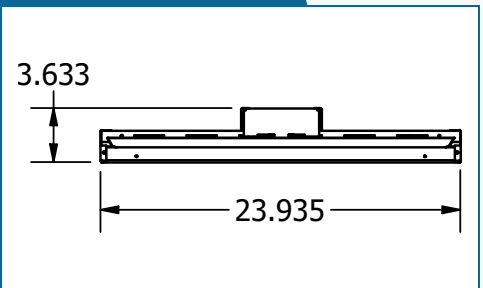

2' 10L-24L Battery

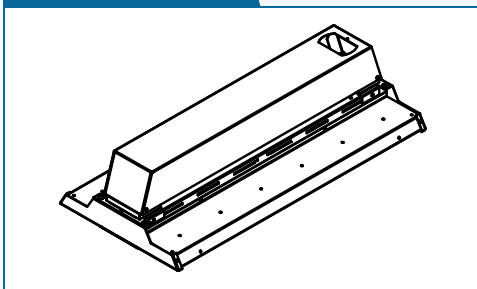

2' 10L-24L Battery End

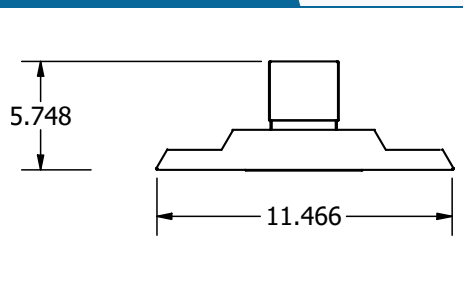

2' 10L-24L Battery Side

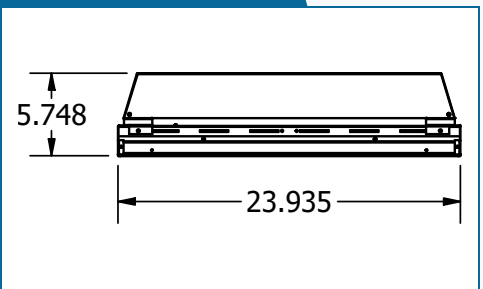

Pendant View

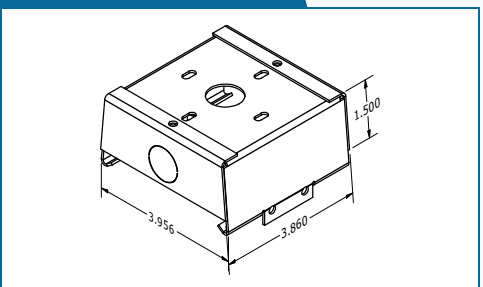

BLHJ 2' 28L-48L Dimensions

Below are the dimensions for the 2' 28L-48L BLHJ configurations.

2' 28L-48L Standard

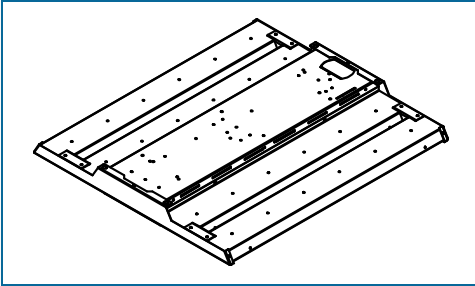

2' 28L-48L Standard End

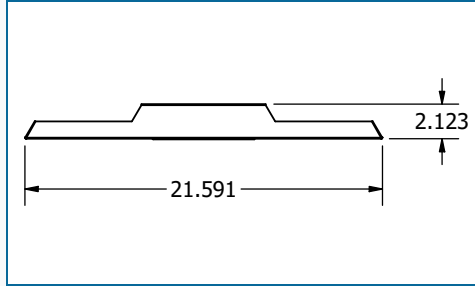

2' 28L-48L Standard Side

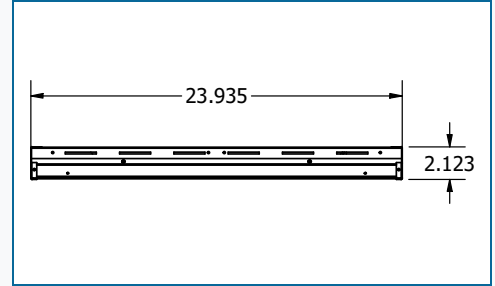

2' 28L-48L Pendant

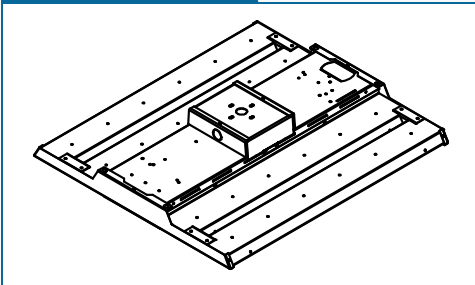

2' 28L-48L Pendant End

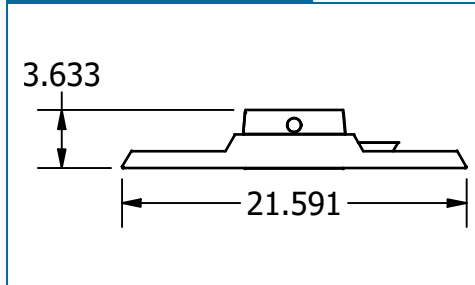

2' 28L-48L Pendant Side

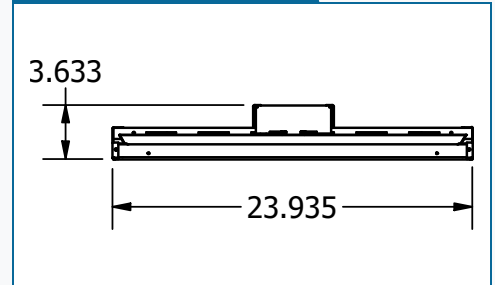

2' 28L-48L Battery

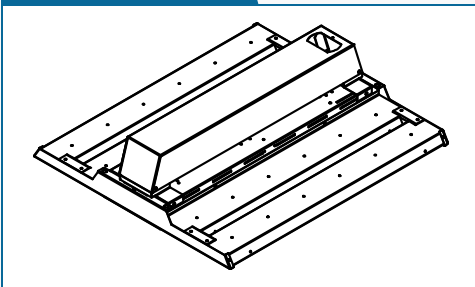

2' 28L-48L Battery End

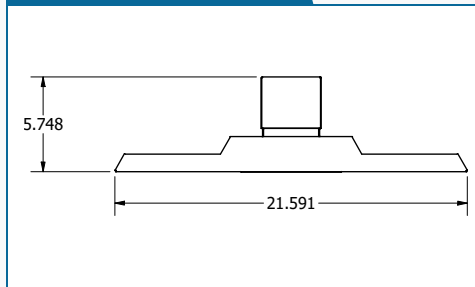

2' 28L-48L Battery Side

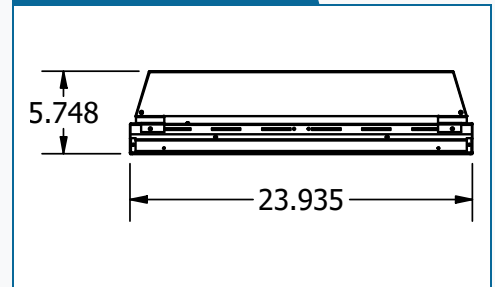

Pendant View

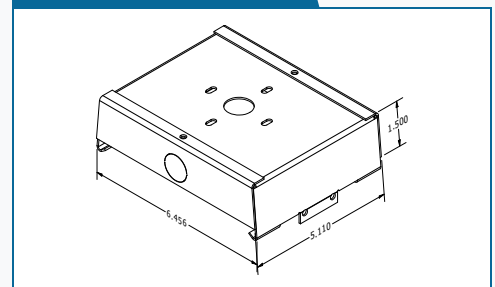

BLHJ 4' 20L-48L Dimensions

Below are the dimensions for the 4' 20L-48L BLHJ configurations.

4' 20L-48L Standard

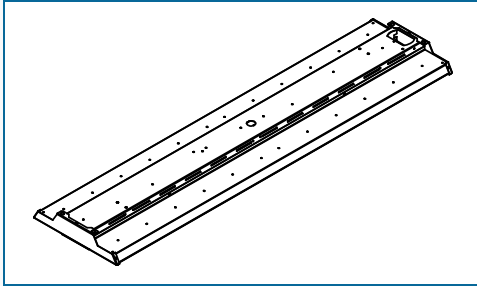

4' 20L-48L Standard End

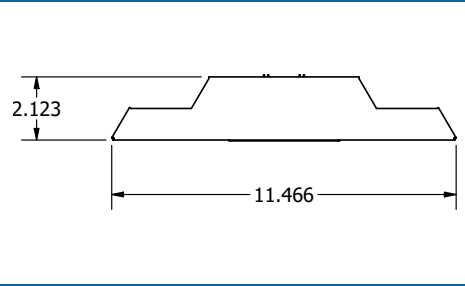

4' 20L-48L Standard Side

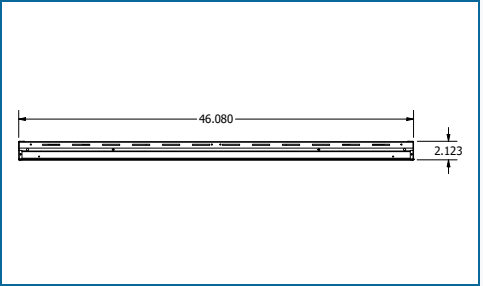

4' 20L-48L Pendant

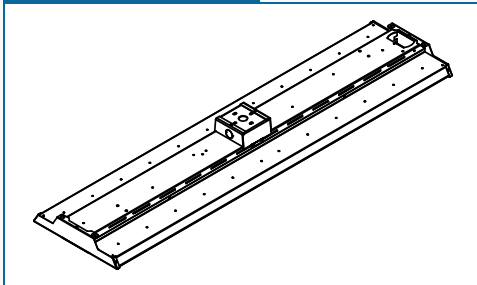

4' 20L-48L Pendant End

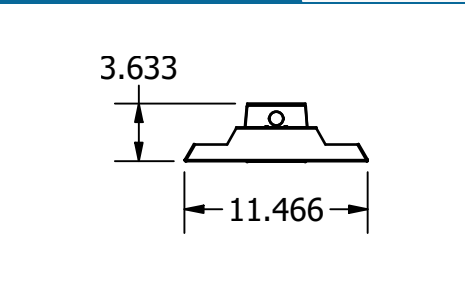

4' 20L-48L Pendant Side

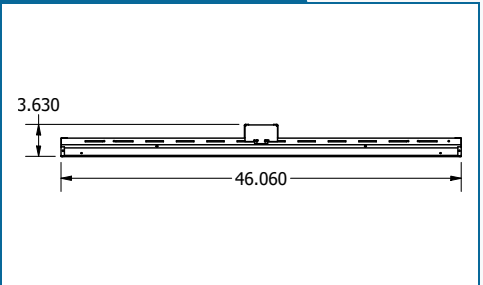

4' 20L-48L Battery

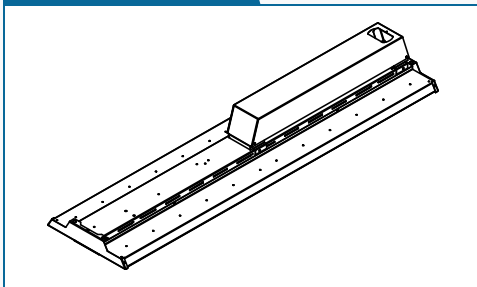

4' 20L-48L Battery End

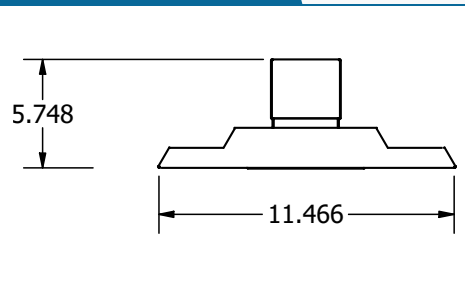

4' 20L-48L Battery Side

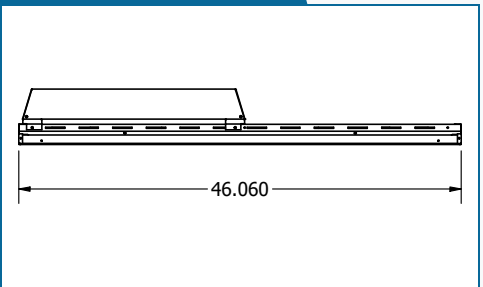

Pendant View

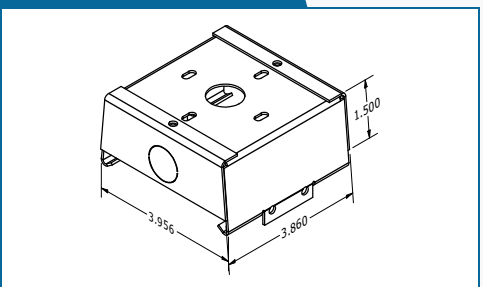

BLHJ 4' 56L-96L Dimensions

Below are the dimensions for the 4' 56L-96L BLHJ configurations.

4' 56L-96L Standard

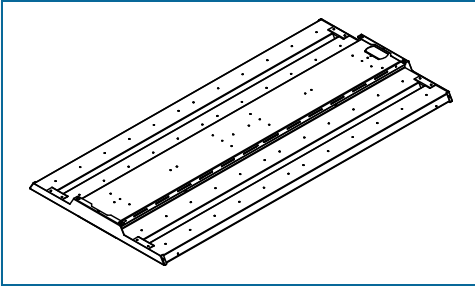

4' 56L-96L Standard End

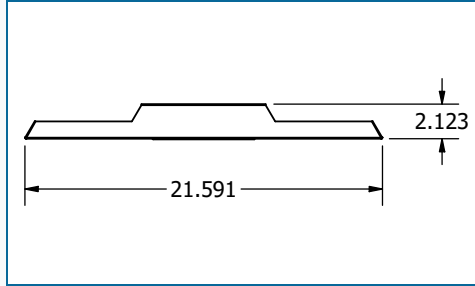

4' 56L-96L Standard Side

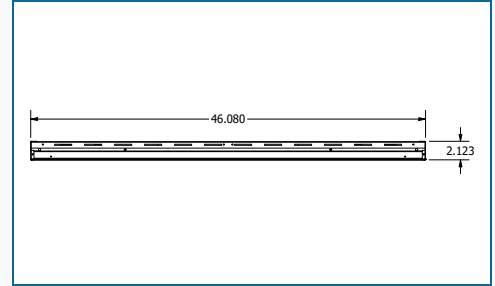

4' 56L-96L Pendant

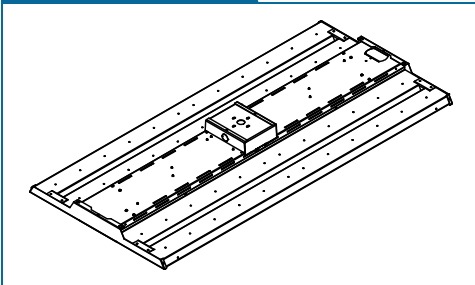

4' 56L-96L Pendant End

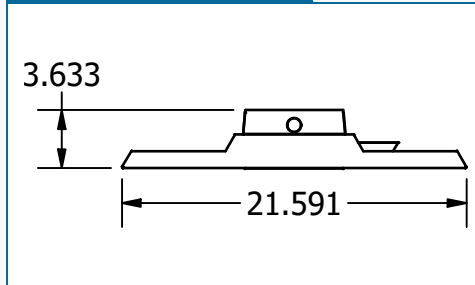

4' 56L-96L Pendant Side

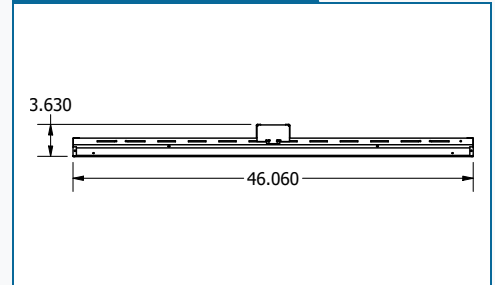

4' 56L-96L Battery

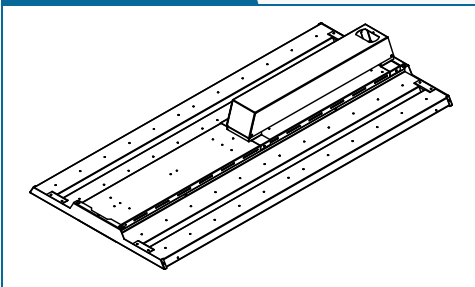

4' 56L-96L Battery End

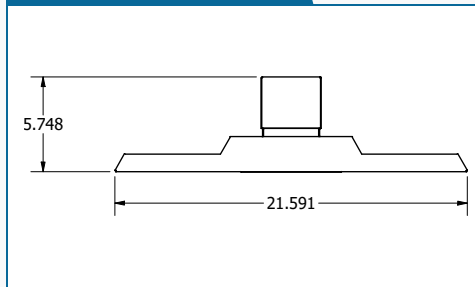

4' 56L-96L Battery Side

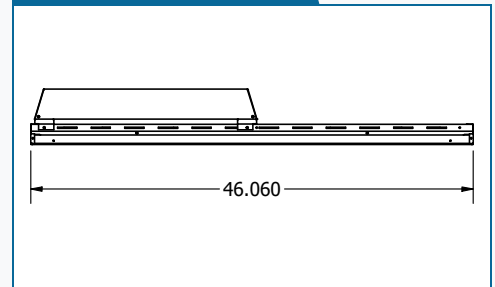

Pendant View

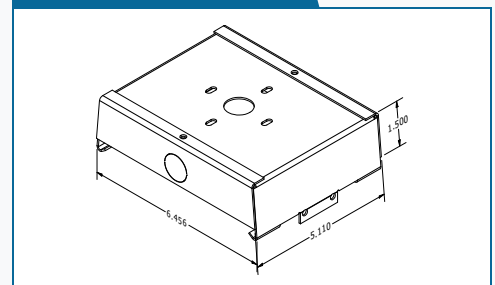

BLHJ-4'-96L-850-L69

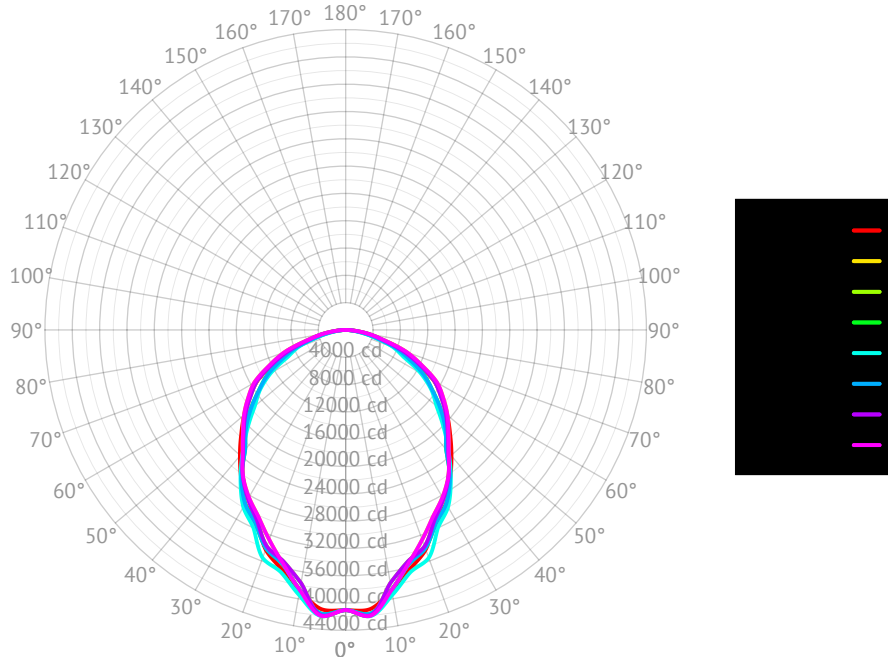

Based on 'BLHJ-4FT-96L-850-L69'
ie. (BLHJ, 4 foot, 96000lm, 80 CRI, 5000K, w/ L69 Lens)

Cone of Light

Mtg Height	Light Level	Beam Diameter
6.0 ft	1140.2 fc	12.6 ft
8.0 ft	641.4 fc	16.7 ft
10.0 ft	410.5 fc	20.9 ft
12.0 ft	285.1 fc	25.1 ft
14.0 ft	209.4 fc	29.3 ft
16.0 ft	160.3 fc	33.5 ft

BLHJ-4'-96L-850-L81

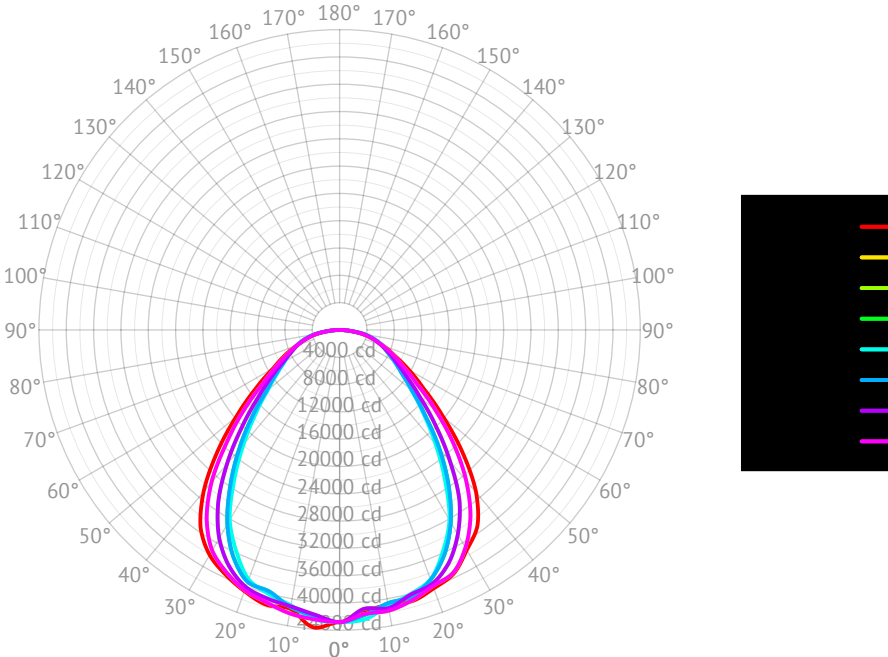

Based on 'BLHJ-4FT-96L-850-L81'
ie. (BLHJ, 4 foot, 96000lm, 80 CRI, 5000K, w/ L81 30x60 Aisle Lens)

Cone of Light

Mtg Height	Light Level	Beam Diameter
6.0 ft	1189.2 fc	13.4 ft
8.0 ft	668.9 fc	17.8 ft
10.0 ft	428.1 fc	22.3 ft
12.0 ft	297.3 fc	26.8 ft
14.0 ft	218.4 fc	31.2 ft
16.0 ft	167.2 fc	35.7 ft

BLHJ-4'-96L-850-L82

Cone of Light

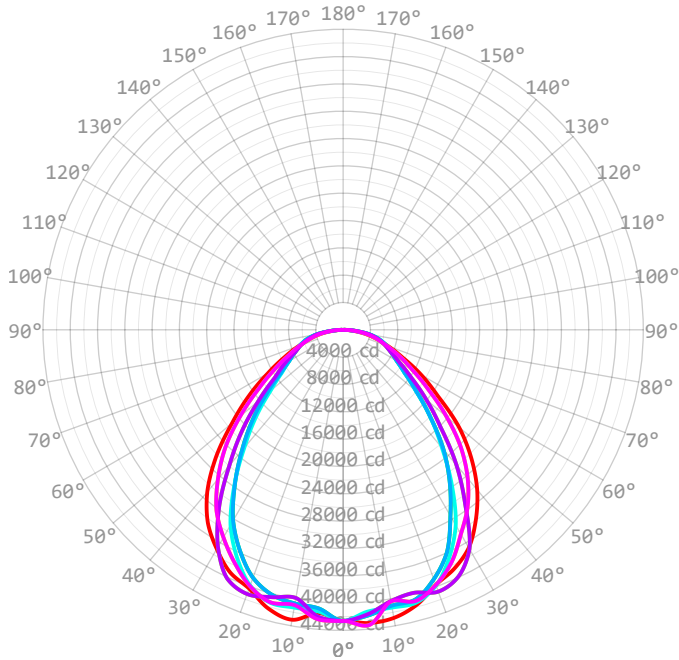

Mtg Height	Light Level	Beam Diameter
6.0 ft	1183.8 fc	14.3 ft
8.0 ft	665.9 fc	19.1 ft
10.0 ft	426.2 fc	23.8 ft
12.0 ft	295.9 fc	28.6 ft
14.0 ft	217.4 fc	33.4 ft
16.0 ft	166.5 fc	38.1 ft

Based on 'BLHJ-4FT-96L-850-L82'
 ie. (BLHJ, 4 foot, 96000lm, 80 CRI, 5000K, w/ L82 10x60 Aisle Lens)

BLHJ Emergency Driver Output

Lumen Package(2FT)	Lumen Output(lm)	Lumen Package(4FT)	Lumen Output(lm).1
10L	3700lm	20L	3700lm
12L	3700lm	24L	3700lm
14L	3700lm	28L	3700lm
16L	3700lm	32L	3700lm
18L	3700lm	36L	3700lm
20L	3700lm	40L	3700lm
22L	3700lm	44L	3700lm
24L	3700lm	48L	3700lm
26L	3700lm	56L	3700lm
28L	3700lm	60L	3700lm
30L	3700lm	64L	3700lm
32L	3700lm	72L	3700lm
36L	3700lm	80L	3700lm
40L	3700lm	88L	3700lm
44L	3700lm	96L	3700lm
48L	3700lm	NaN	NaN

BLHJ Emergency Battery Plan 20W

Emergency Lighting	Solution System Components	System Operation
Option Code 'B17' - UL 924 listed components that are factory installed in the luminaire	UL 924 listed 20-watt battery integral to the luminaire	Loss of normal power is detected by the B17 emergency light solution and the power supply is switched automatically to the 20-watt integral battery pack which powers the emergency LED lighting driver.
	UL 924 listed LED emergency lighting driver integral to the luminaire	The battery pack and emergency LED driver are UL 924 certified to provide a minimum of 90-minutes of emergency lighting.
	Wiring options for both switched and unswitched emergency lighting	

BLHJ Emergency Lighting Wiring

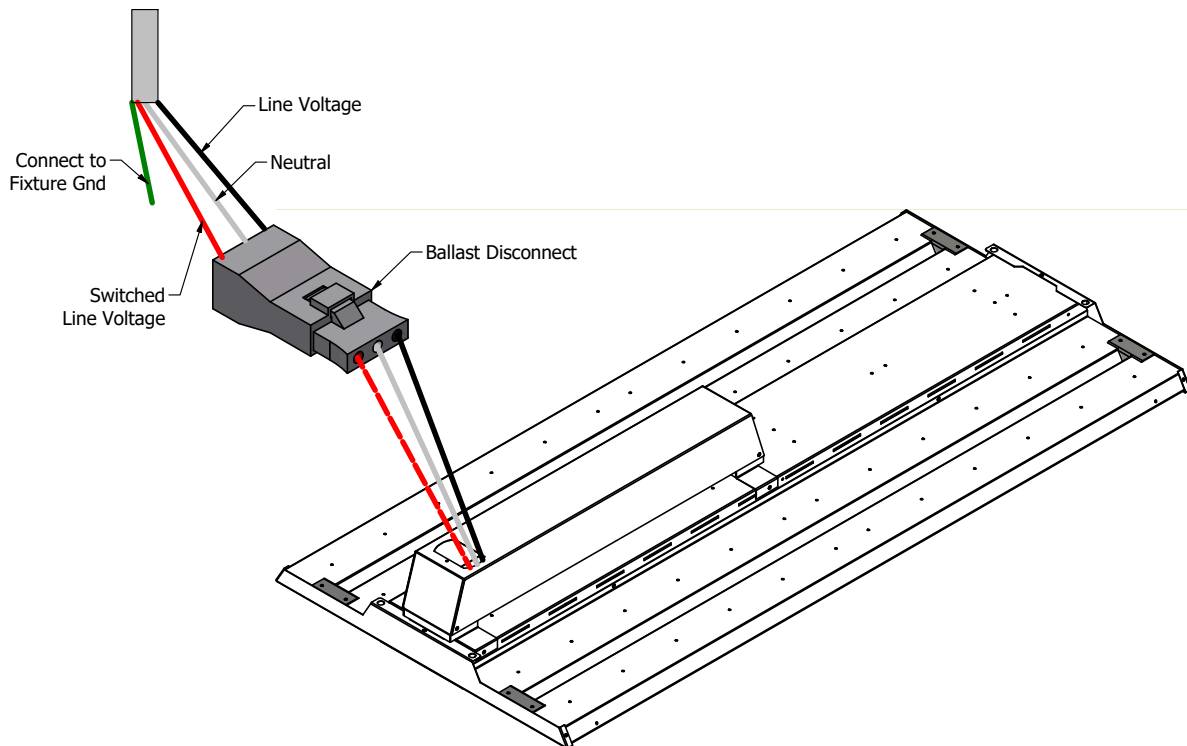

Note: If there is no switched line voltage then place jumper from black to red.



Gallery Information

Below you will find images of relevant products and configurations for the BLHJ.



Gallery Information

Below you will find images of relevant products and configurations for the BLHJ.

